

MMK MML

Multi-Stage Ring Section Pumps



TORISHIMA PUMP

MMK, MML Multistage Ring Section Pumps

Introduction

Horizontal, radially split ring section pump, single flow, multistage. The casings are sealed by flat gasket and held together by the bolts. The stage casing and the tie bolts are encased in a steel cladding. The pump feet are arranged either below the pump or at center line according to the number of stages and the temperature.

Applications

Used for

- boiler feed pump
- condensate pump
- fire-fighting
- district installations for pumping clean water
- general water supply

Performance Range

Capacities	up to 1800m ³ /h (7930U.S.gpm)
Total head	up to 500m (1640ft)
Temperature	up to 250°C (482°F)
Max. pump suction pressure	up to 29.4bar (426psi)
Max. pump discharge pressure	up to 53bar (767psi)
Speed	up to 3600min ⁻¹
Size	DN 40 to 350mm (1 ² / ₃ to 14")

Materials

The following materials are used for standard material combinations:

Suction, discharge and stuffing box casing	Cast iron, Bronze, Cast steel, Ductile iron
Stage casing	Cast iron, Bronze, Cast steel, Ductile iron
Impellers, and diffusers	Cast iron, Bronze, Stainless steel
Shaft	Carbon steel
Balance disc/seat	Cast iron, 13%Cr cast steel, 18%Cr cast steel,
Casing wear ring	Cast iron, Bronze, 2.5%Ni cast iron



Booster pumps in water supply system of buildings



Boiler feed pumps in district heating and cooling plant



Distributing pumps in small-capacity water works



Fire-fighting pump

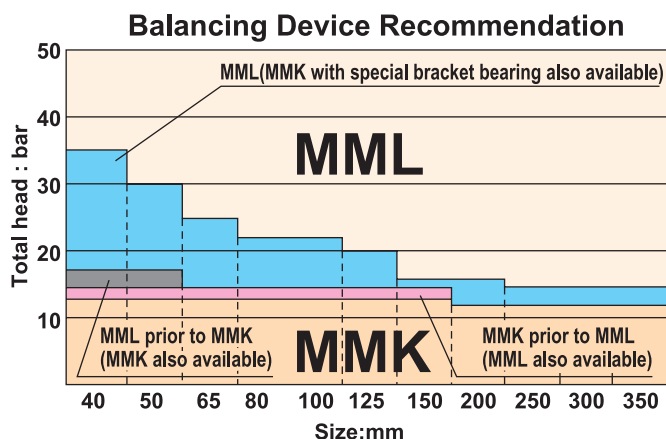

Flexible Design to Meet All Application Requirements

Bearing Options

- MMK—A roller bearings at the suction end, and a ball bearing at the discharge end
- MML—Roller bearings on both ends
- All bearing fitted with oil level indicator as standard

Flexible nozzle design

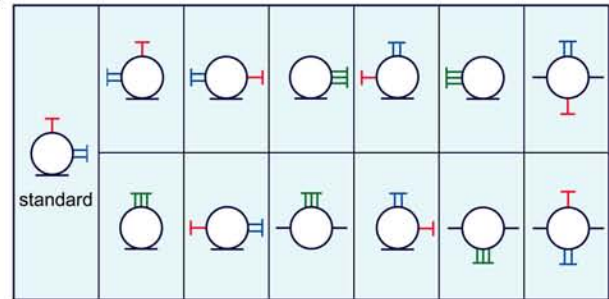

Nozzle orientation viewed from driver side
 T :Suction, T :Delivery, — :Foot

MMK

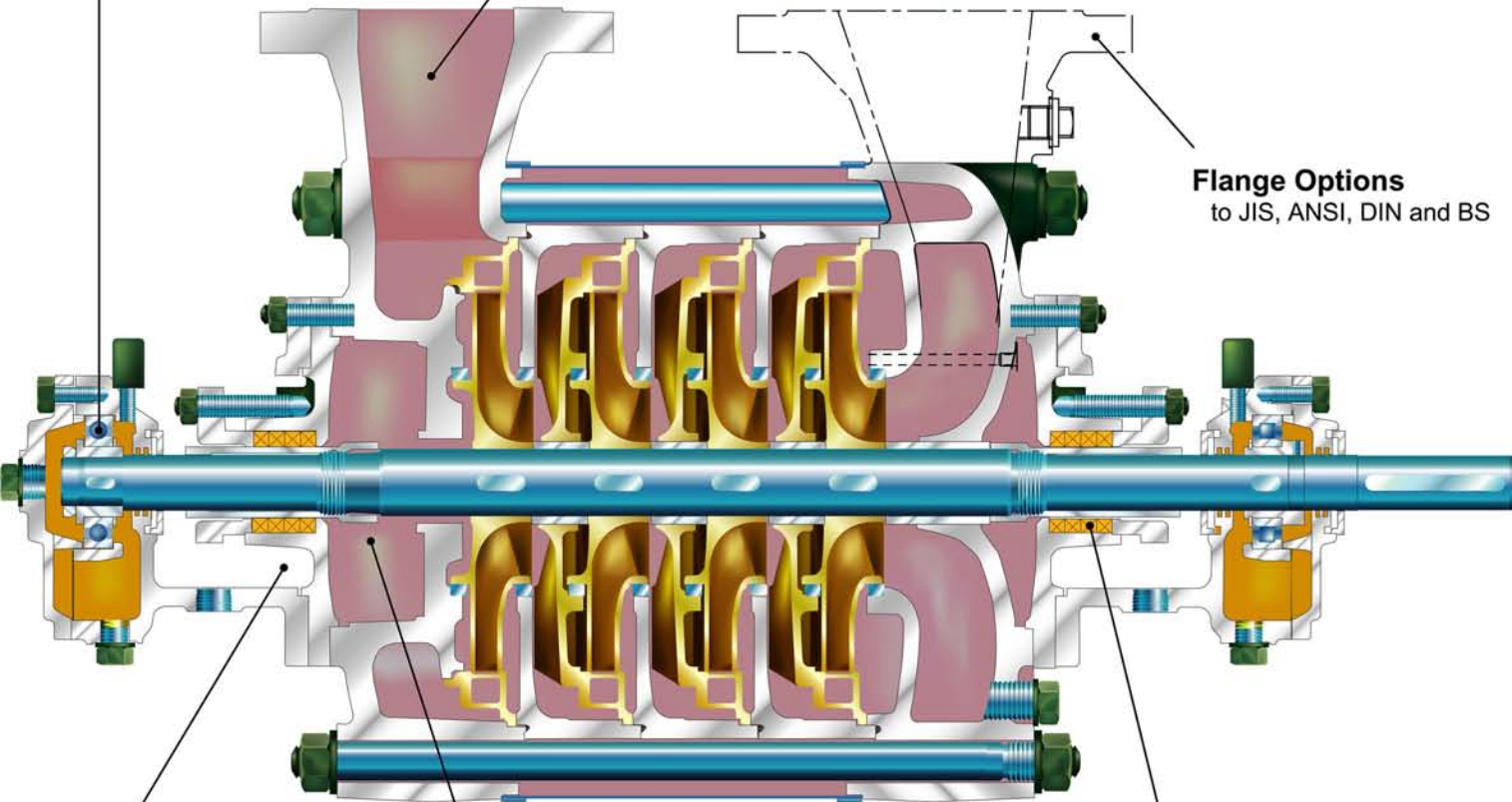

Flange Options
 to JIS, ANSI, DIN and BS

Stuffing Box Options

- designed to suit pumped fluid
- Cooled
- Uncooled

Balancing Device Options

- MMK—Deep groove or angular contact ball bearings+balance holes in impellers
- MML—Balance disk and balance seat

Shaft Seal Options

- Gland packing
- Mechanical seal

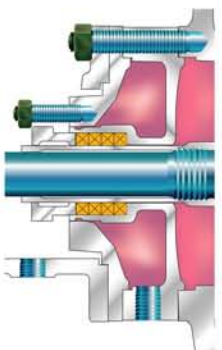

Cooled stuffing box

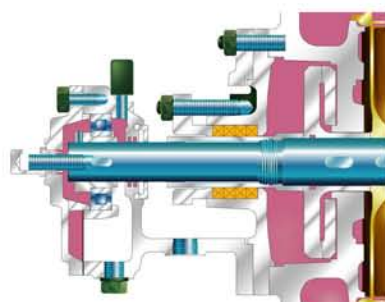

MML—Balance disk and seat

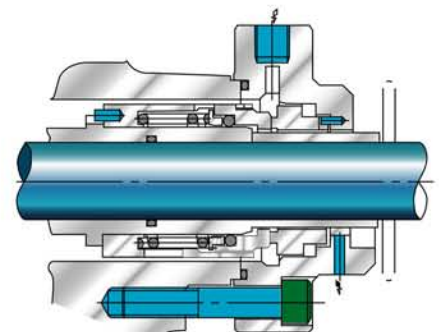

Single acting balanced mechanical seal
 Type:HB2700BNUH

On MML pumps, the minimum delivery pressure should not be allowed to drop below 12.7bar(184psi) to maintain balance device clearance.

Selection Charts

50Hz-2P(3000min⁻¹)

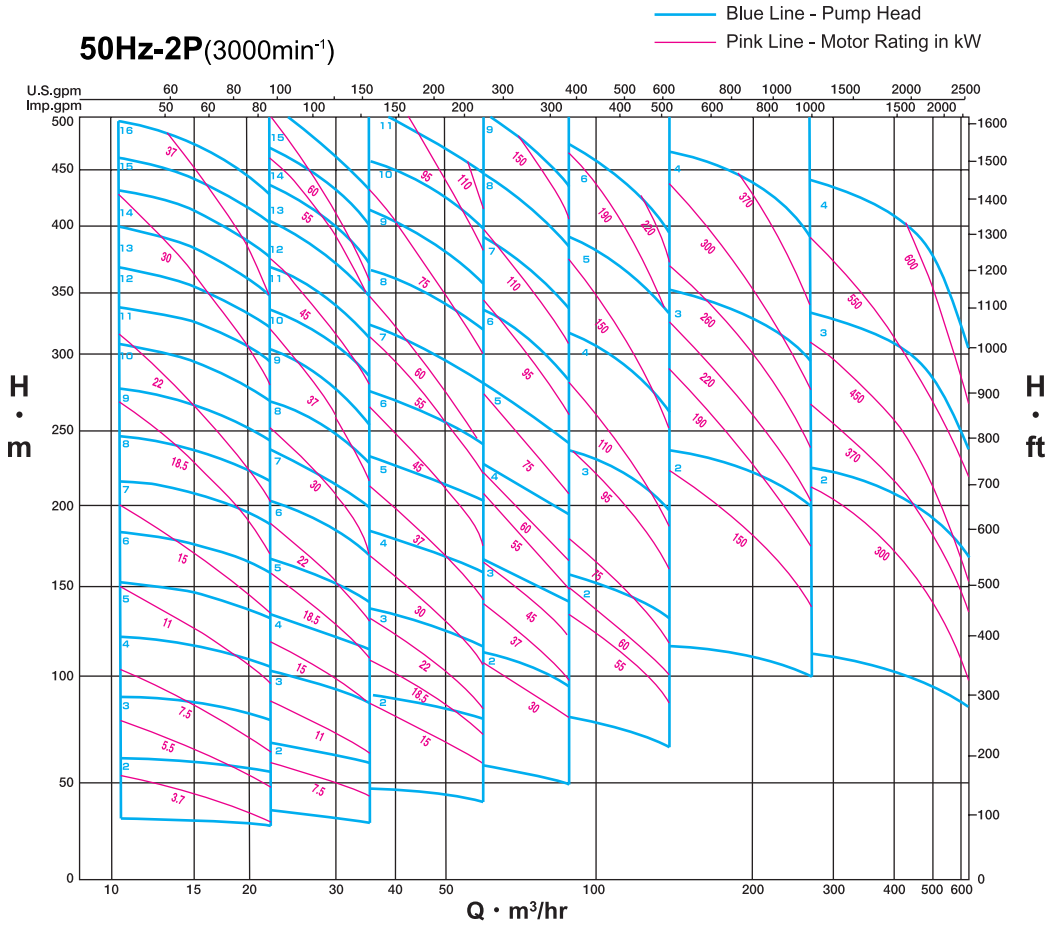

Size	40	50	65	80	100	125	150
------	----	----	----	----	-----	-----	-----

60Hz-2P(3600min⁻¹)

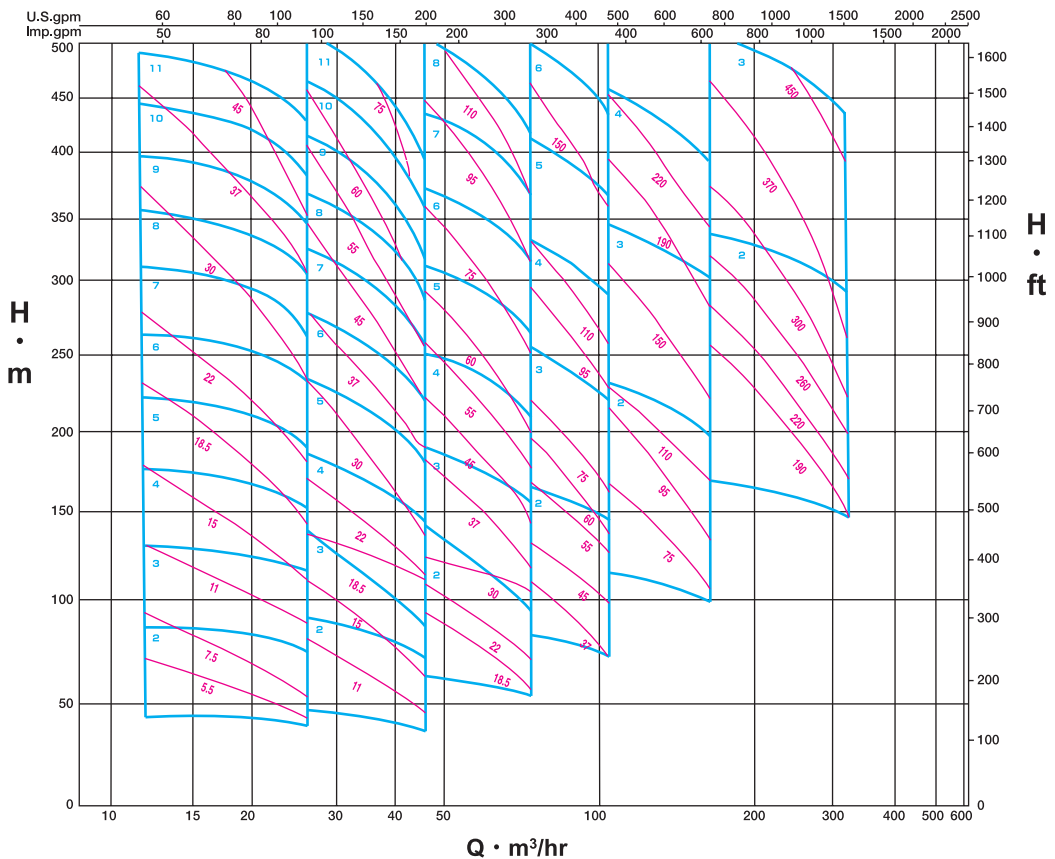

Size	40	50	65	80	100	125
------	----	----	----	----	-----	-----

50Hz-4P(1500min⁻¹)

Blue Line - Pump Head
Pink Line - Motor Rating in kW

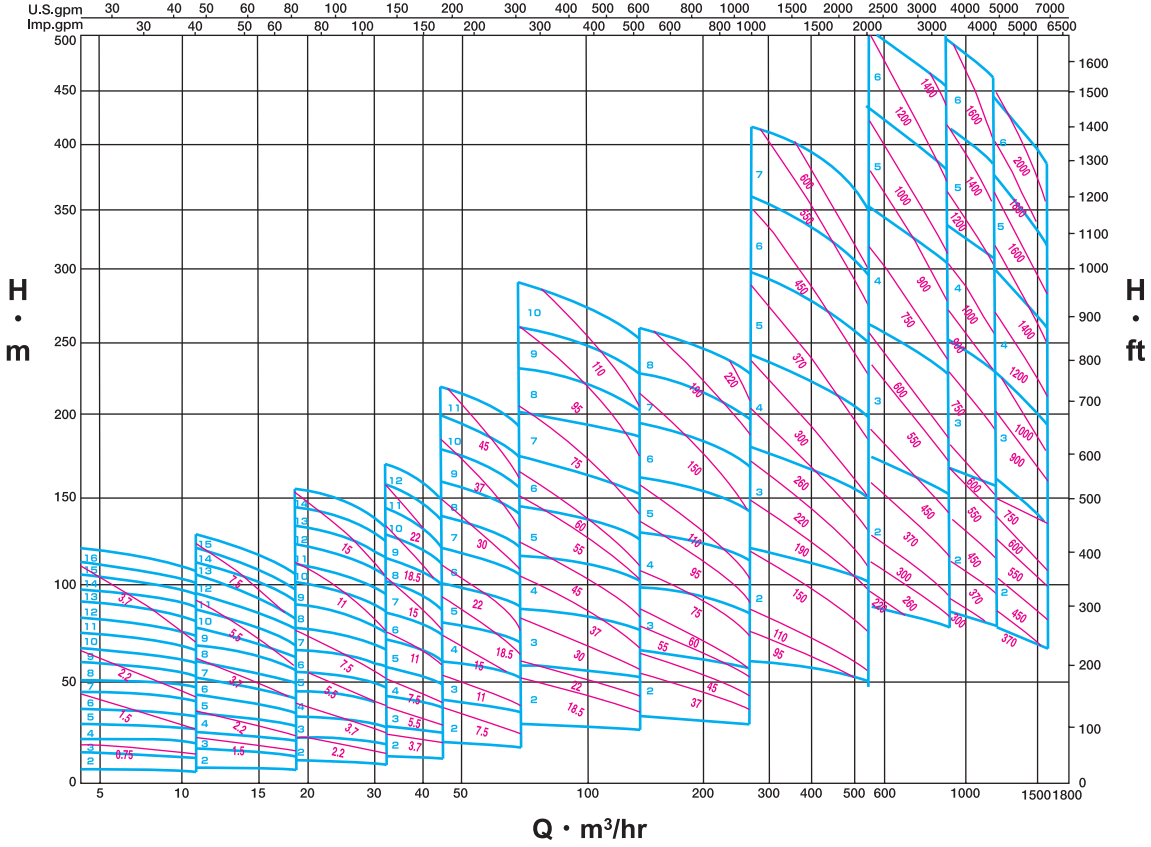

Size	40	50	65	80	100	125	150	200	250	300	350
------	----	----	----	----	-----	-----	-----	-----	-----	-----	-----

60Hz-4P(1800min⁻¹)

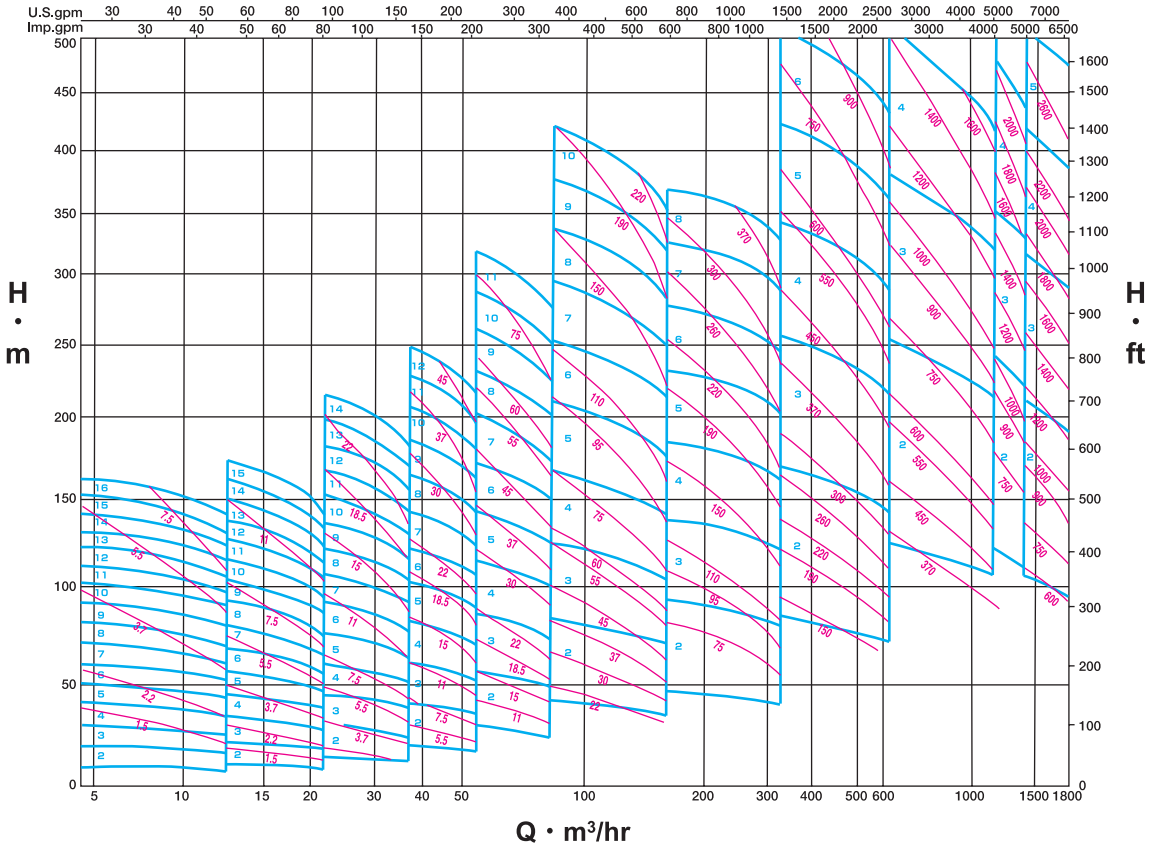

Size	40	50	65	80	100	125	150	200	250	300	350
------	----	----	----	----	-----	-----	-----	-----	-----	-----	-----

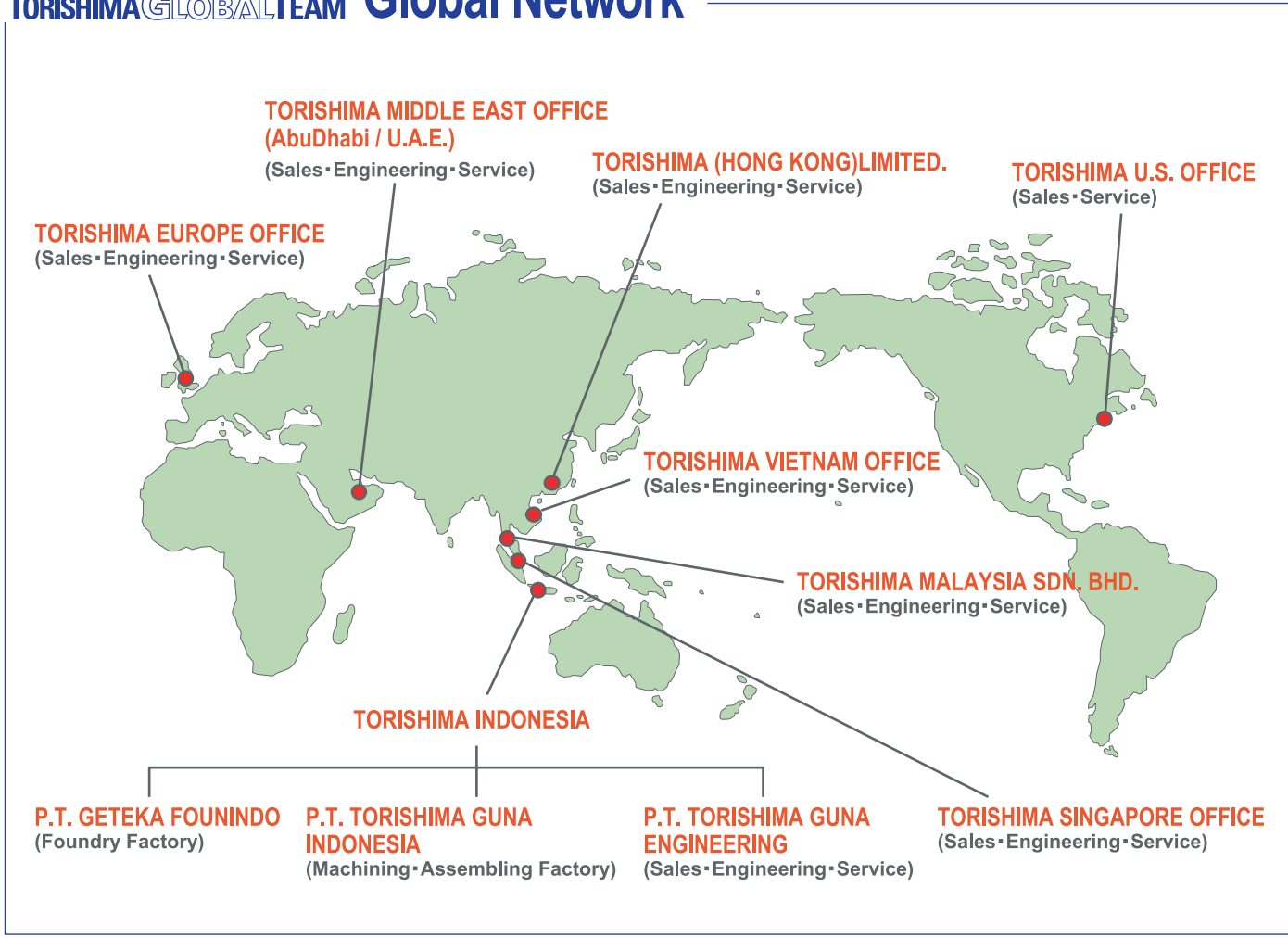

TORISHIMA PUMP MFG. CO., LTD.

Head Office & Works: 1-1-8, Miyata-cho, Takatsuki City, Osaka, Japan. Phone: 072-695-0551 Fax: 072-693-1288

TORISHIMA HONG KONG

TORISHIMA (HONG KONG) LIMITED
 Unit 605, 6/F., Tower II, Enterprise Square,
 9 Sheung Yuet Road, Kowloon Bay,
 Kowloon, Hong Kong
 Phone: (852)2795-1838 Fax: (852)2754-3293

TORISHIMA INDONESIA

P.T. TORISHIMA GUNA INDONESIA
 (Machining, Assembling Factory)
 Jalan Rawa Sumur Timur No.1, Pulogadung
 Industrial Estate, P.O Box.:1160,
 Jakarta Indonesia
 Phone: (62)021-460-3963 Fax:(62)021-460-3937

TORISHIMA U.A.E.

MIDDLE EAST OFFICE
 5th Floor, office No.503, Al Salmeen
 Golden Tower, P.O Box.:72197,
 Electra Street, Abu Dhabi. U.A.E.
 Phone: (971)2-6743880 Fax:(971)2-6743881

TORISHIMA VIETNAM

VIETNAM OFFICE
 No.76 Bui Thi Xuan Street, Hai Ba Trung
 District, Hanoi, Socialist Republic of Vietnam
 Phone: (84)4-943-7880 Fax: (84)4-943-7876

P.T. TORISHIMA GUNA ENGINEERING

Jalan Rawa Sumur Timur No.1, Pulogadung
 Industrial Estate, P.O Box 1160
 Jakarta Indonesia
 Phone: (62)021-460-3963 Fax:(62)021-460-3937

TORISHIMA U.K.

EUROPE OFFICE
 c/o Krg Industries Ltd, Russel Colt St,
 Coatbridge Lanarkshire ML5 2BN, Scotland
 Phone: (44)1236 441630 Fax:(44)1236 702875

**TORISHIMA SINGAPORE
 SINGAPORE OFFICE**

30 Ubi Crescent #01-02 Ubi Techpark
 Singapore 408566
 Phone: (65)6779-0123 Fax: (65)6779-6900

P.T. GETEKA FOUNINDO(Foundry Factory)

JL Pulo Ayang Kav. AA2 Pulogadung
 Industrial Estate P.O Box 1160 JAT
 Jakarta 13011, Indonesia
 Phone: (62)021-460-3963 Fax: (62)021-460-3937

TORISHIMA U.S.A.

U.S.A. OFFICE
 82B Daniels Road, Charlton,
 MA01507, the United States of America
 Phone: (1)866-374-1130 Fax:(1)508-248-9321

TORISHIMA MALAYSIA

TORISHIMA MALAYSIA SDN.BHD
 Suite 1906, 19th Floor Kenanga International
 Jalan Sultan Ismail 50250 Kuala Lumpur,
 Malaysia
 Phone: (603)2715-0068 Fax: (603)2715-0019